



A-1 SCAFFOLD MFG., INC.

590 Commerce Parkway | Hays, KS 67601
Ph 785.621.5121 | Fax 785.621.5122
www.a1scaffoldingmfg.com

Cuplock System Scaffold



VERTICALS

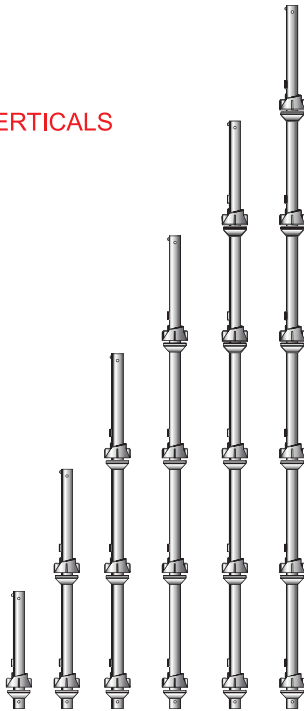

Part Number	Description	Weight (lbs.)
C-1V	1' Vertical	4.0
C-33V	3' 3" Vertical	12.0
C-411V	4' 11" Vertical	18.0
C-66V	6' 6" Vertical	25.0
C-82V	8' 2" Vertical	30.0
C-910V	9' 10" Vertical	37.0

HORIZONTALS

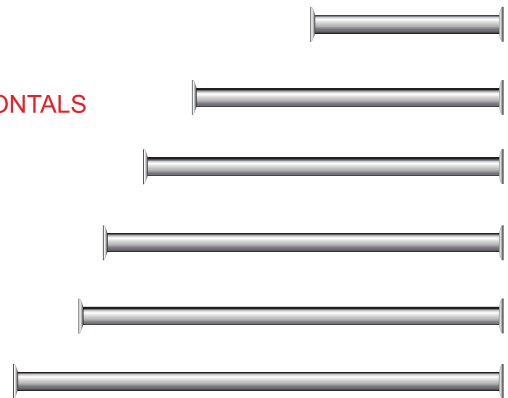

Part Number	Description	Weight (lbs.)
C-110H	1' 10" Horizontal	5.0
C-27H	2' 7" Horizontal	7.0
C-211H	2' 11" Horizontal	8.0
C-3H	3' Horizontal	9.5
C-36H	3' 6" Horizontal	10.0
C-4H	4' Horizontal	11.0
C-41H	4' 1" Horizontal	11.0
C-411H	4' 11" Horizontal	13.0
C-5H	5' Horizontal	13.0
C-511H	5' 11" Horizontal	15.0
C-6H	6' Horizontal	15.5
C-7H	7' Horizontal	18.5
C-8H	8' Horizontal	21.0
C-82H	8' 2" Horizontal	21.0
C-9H	9' Horizontal	24.0
C-10H	10' Horizontal	27.0

SWIVEL BRACES

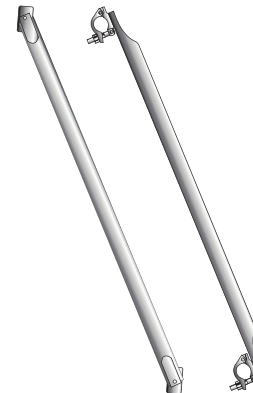

Part Number	Description	Weight (lbs.)
C-7FB	7' Swivel Face Brace	22.0
C-8FB	8' Swivel Face Brace	28.0
C-82FB	8' 2" Swivel Face Brace	28.0
C-10FB	10' Swivel Face Brace	30.0
C-104CB	10' 4" Swivel Clamp Brace	28.5

TRUSSES

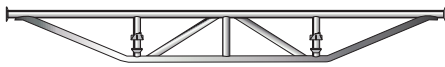

Part Number	Description	Weight (lbs.)
C-8TB	8' Horizontal Trussed Bearer	50.0
C-10TB	10' Horizontal Trussed Bearer	62.0
C-16TB	16' Horizontal Trussed Bearer	100.0

BOARD BRACKETS

Part Number	Description	Weight (lbs.)
C-1BB	One Board Bracket	3.5
C-2BB	Two Board Bracket	13.5
C-3BB	Three Board Bracket	17.0

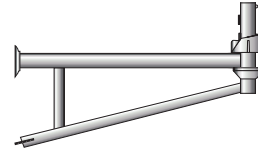

CANTILEVERS

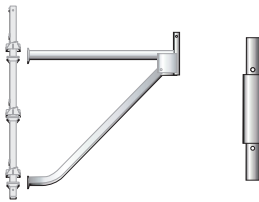

Part Number	Description	Weight (lbs.)
C-AF40	Cantilever "A" Frame 4'	44.1
C-AF50	Cantilever "A" Frame 5'	54.1
C-AF60	Cantilever "A" Frame 6'	64.1
CEA	Cantilever Extension Adaptor	5.5

Part Number	Description	Weight (lbs.)
C-3AL	3' Access Ladder	11.0
C-5AL	5' Access Ladder	17.0
C-10AL	10' Access Ladder	33.0
C-ALB	Access Ladder Bracket	5.5

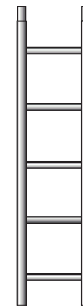

ACCESS LADDERS & BRACKETS



STAIR STRINGERS

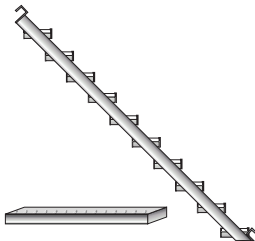

Part Number	Description	Weight (lbs.)
C-8SSL	8' Stair Stringer (Left)	62.0
C-8SSR	8' Stair Stringer (Right)	62.0
C-82SSL	8' 2" Stair Stringer (Left)	62.0
C-82SSR	8' 2" Stair Stringer (Right)	62.0
C-4ST	4' Stair Tread	18.0

SCREW JACKS / BASKETS & RACKS

Part Number	Description	Weight (lbs.)
SJB	Screw Jack W/Baseplate	12.0
SJSW	Screw Jack w/Swivel Baseplate	15.0
CRS	40"X40"X32" Cup Rack -Small	116.0
CRL	40"X40"X47" Cup Rack -Large	153.0
CRBS	40"X40"X32" Cup Rack Basket -Small	193.0

